



befame

Laurent

Laurent is Bellissa's younger brother – just like her it is made of modules, it also has soft and very comfortable seat cushions, thanks to a special combination of corrugated springs and highly flexible foam. Just by looking at it, you can imagine the comfort of resting on this piece of furniture. You can comfortably sit back and enjoy aromatic coffee and admire the views outside the window, or lie down under a warm blanket, accompanied by your favourite book or film. Laurent is slightly more versatile in style, making it easier to fit into various types of interiors. Its charm is enhanced by a decorative trim and loose decorative pillows.

Corner sofas

Available in a left-hand or right-hand configuration. The sets below are left-hand facing. _____

LAURENT SET 1

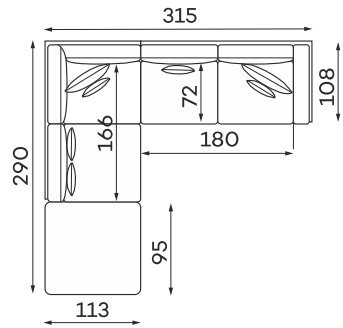

LAURENT SET 2

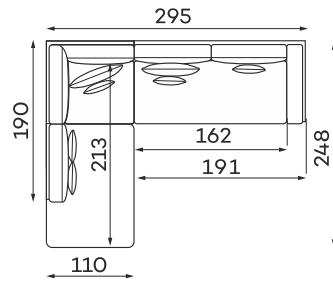

LAURENT SET 3

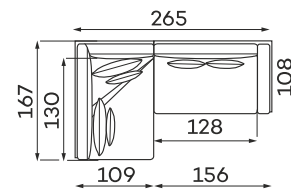

LAURENT SET 4

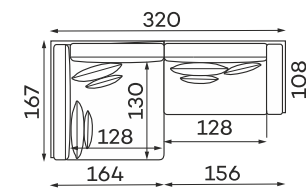

Sofas

2-SEATER SOFA WITHOUT

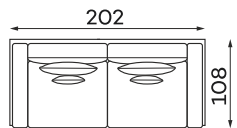

3-SEATER SOFA WITHOUT

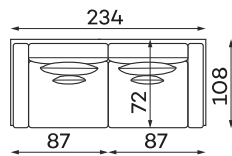

4-SEATER SOFA WITHOUT

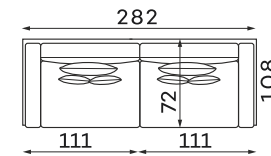

Modular units

CORNER UNIT

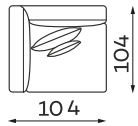

1,5-SEATER UNIT

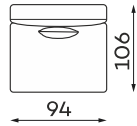

1,5-SEATER ONE ARM UNIT

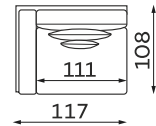

2-SEATER ONE ARM UNIT

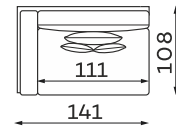

2,5-SEATER ONE ARM UNIT

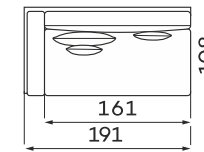

3-SEATER ONE ARM UNIT

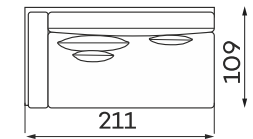

CHAISE UNIT S

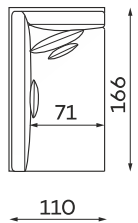

CHAISE UNIT M

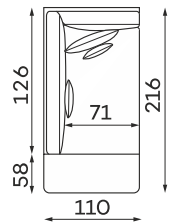

CHAISE UNIT L

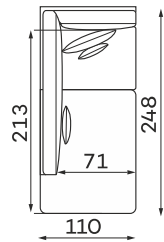

CHAISE UNIT XL

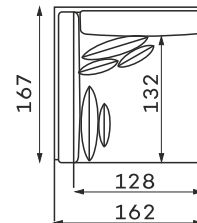

SMALL POUFFE

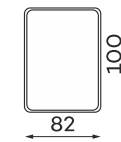

POUFFE

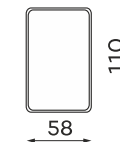

LARGE POUFFE

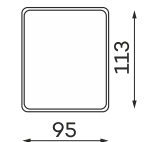

Pouffe height: 45

All dimensions of upholstered furniture are given with a tolerance of +/- 4 cm.

Other dimensions

Leg A, height 10 cm:

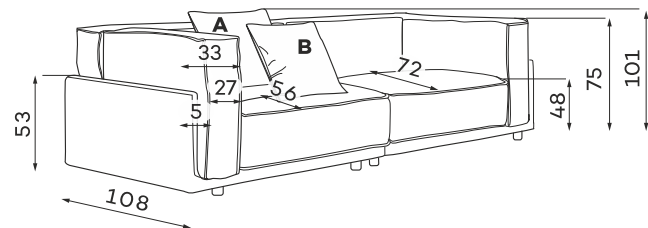

Leg B, height 7 cm:

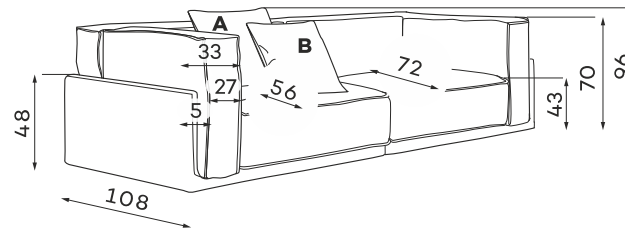

CUSHION A

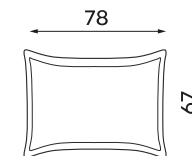

CUSHION B

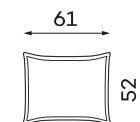

Leg colors available

Choose one of the two available legs, wood with gold or a version where the leg will be invisible.

Leg B, height 5 cm - onvisible

BLACK

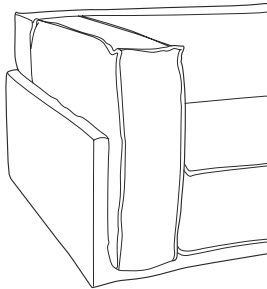

What makes the Laurent sofa stand out?



They make the seat more flexible and provide excellent underlying support for a highly flexible foam layer.



The highly-flexible foam improves the durability and elasticity of the seat, preventing deformations.



You can choose the fabric from dedicated series, including easy-to-clean fabrics.



The ergonomic and comfortable design of the backrest and seat perfectly fits the curve of the human body.



The upholstered back allows you to put it in the middle of the living room.



The series comes with several colours of legs. Choose your own colour. Do you want to buy the same legs for a chest of drawers? Of course, you can!

V 02. Product images are for illustrative purposes only and may differ from the actual product. Dimensions in technical descriptions are approximate and may vary (with a tolerance of +/- 3% -4%). The company reserves the right to change the technical specifications provided in product datasheets for regular updates without prior notice.